

Article number: 51836208080010

Description: Vibration damper GMF 48/23

Measures

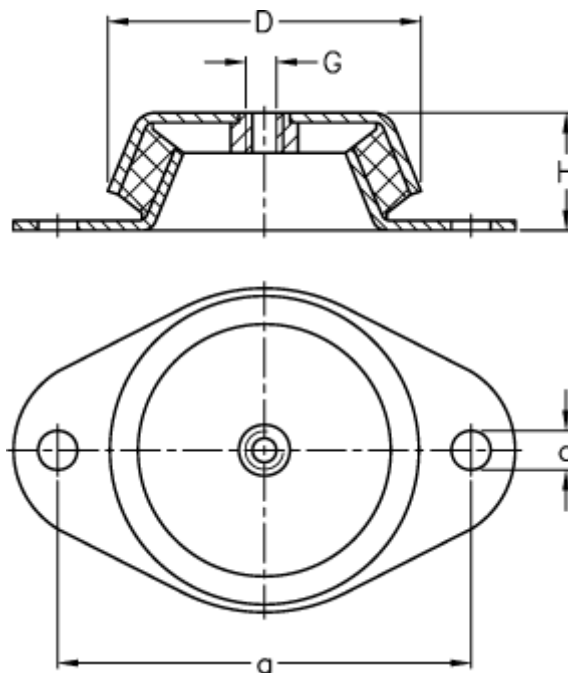

a	= 68
D	= 48
d	= 6.2
G	= M8
H	= 23
Load (daN)	= 100